



Grown...to meet challenges

INSTRUCTION MANUAL

SLP-VIBROSONDE

Vibrating Rod

Version 2.3

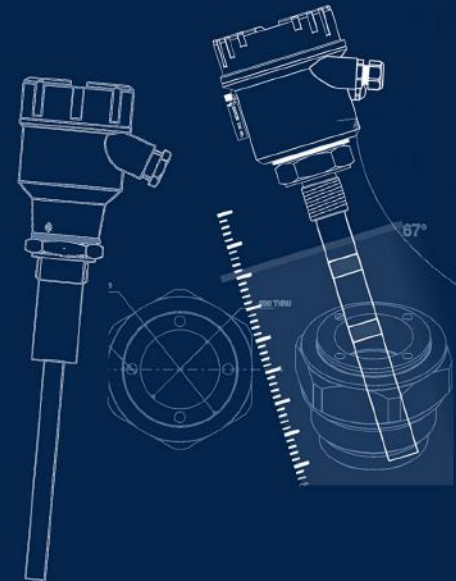

SAPCON INSTRUMENTS PVT. LTD.

30+ Years in Process Control Instrumentation

An ISO 22000 company

www.sapconinstruments.com

Contents

Revision History	4
1 Introduction	5
2 Operating Principle	5
3 Features	5
4 Applications	5
5 Electrical Specifications	6
6 Application Specifications	6
7 Mechanical Specifications	7
8 Installation & Handling Guidelines	7
9 Electrical Connections	8
10 Sensitivity Settings	9
11 Cover Delay	9
12 Uncover Delay	10
13 Failsafe Settings	10
14 Troubleshooting & Indications	11
14.1 Output Indications	11
14.2 Troubleshooting	11
15 Maintenance	11
16 Customer Support	11
17 Production Selection Chart -Vibrosonde	12

List of Figures

1	Vibrosonde Product Image	5
2	Description of Parts	5
3	Correct Side Mounting	7
4	Instrument Handling	8
5	Electrical Connections	8
6	DIP Switch	9
7	Sensitivity Switch Position	9
8	Setting Sensitivity Value	9
9	Saving Sensitivity Value	9
10	Cover Delay Switch Position	9
11	Setting Cover Delay	10
12	Saving Cover Delay	10
13	Uncover Delay Switch Position	10
14	Setting Uncover Delay	10
15	Saving Uncover Delay	10
16	Failsafe High	10
17	Failsafe Low	11

List of Tables

1	Electrical Specifications	6
2	Application Specifications	6
3	Mechanical Specifications	7

Revision History

Revision	Date	Author(s)	Description
1.0	10 Mar 2014	RND	First Version Editing
1.1	15 Sep 2014	MRK	Applications Revision
1.2	25 May 2015	RND	Features Revision
1.3	20 Nov 2015	RND	Specs Revision
1.4	28 Jul 2016	RND	Specs Revision
2.0	08 Jan 2017	BRND	Revised Format
2.1	17 Sep 2017	BRND	Branding Revisions
2.2	12 Jan 2018	RND	Specs Revision
2.3	05 Jul 2018	BRND	Branding Revisions

1

1

- The images shown in this manual may differ from the actual instrument / housing in terms of dimensions, color and design. Please refer to GA drawings for dimensional details.
- Values (of performance) described in this manual were obtained under ideal testing conditions. Hence, they may differ under industrial environment and settings.

General Instructions

- Instrument shouldn't block the material filling inlet.
- Secure the cover of housing tightly. Tighten the cable glands. For side mounting, the cable glands should point downwards.
- For side mounting, provide a baffle to prevent the material from falling on the probe.
- Make all electrical connections as instructed in the manual. DO NOT power on the device before verifying the connections.

1 Introduction

Vibrosonde is a vibrating rod level limit switch for free-flowing solids having a maximum granule size ≤ 12 mm. It is suitable for level detection in silos, bins, hoppers, etc. where the process temperature ranges between 0°C to $+150^{\circ}\text{C}$. It has no moving parts and can replace rotating paddle level switch in most applications.



Figure 1: Vibrosonde Product Image

2 Operating Principle

A vibrating rod is kept in mechanical vibrations at its resonance frequency by piezo-electric crystals. When the service material covers the rod probe, vibrations are damped which is sense electronically and processed signal is used for switching.

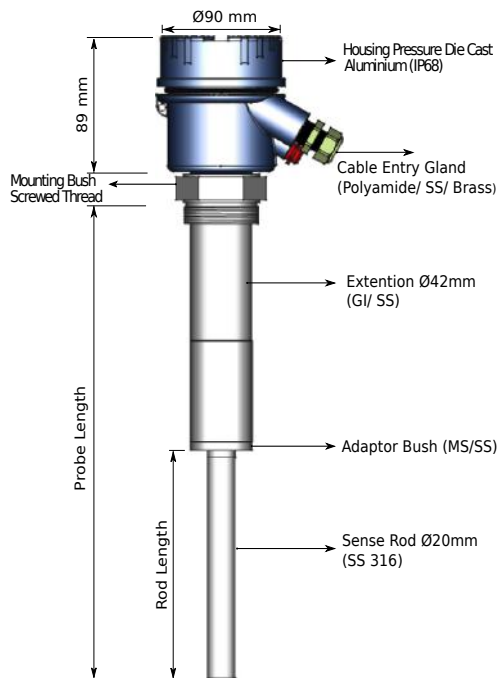

Figure 2: Description of Parts

3 Features

- Low Power Consumption: Less heat, Long life.
- Self-diagnosis.
- External LED indication available with WL option
- Independent of material's electrical properties.

- No moving parts, no wear and tear, maintenance-free.
- IP68 Protection, as per IS 13947.

4 Applications

- Fast Packaging machines for powders, granules
- PET / PVC chips with underwater detection
- Powders, sand & sugar
- Iron ore, sinters & pulverized coal
- Dry sand & Fly-ash
- Food grains
- Cement

5 Electrical Specifications

Please refer to Table 1 for Electrical Specifications.

PARAMETER	VALUE
Input Power Supply	18 - 55V DC and 90 - 265V AC at 50Hz on same terminal
Output	<ul style="list-style-type: none"> • Relay DPDT • Relay SPDT, PNP
Power Consumption	<ul style="list-style-type: none"> • 1.5W (SPDT, PNP) at 24 V • 2.2W (DPDT) at 24 V
Switching	Single-point level switching
Switching Indication	Bi-Color LED on the electronics insert <ul style="list-style-type: none"> • Green - Normal • Red - Alarm External LED between the cable glands(with option WL) <ul style="list-style-type: none"> • Blue - Normal • Red - Alarm
Fail-safe	Field Selectable <ul style="list-style-type: none"> • Open - Fail-safe High (For High Level) • Close - Fail-safe Low (For Low Level)
Time Delay Settings	1 - 25 seconds (For both, Covered and Uncovered Delays)
Operating Temperature	<ul style="list-style-type: none"> • Ambient Temperature: 0°C to 65°C • Process Temperature: 0°C to 100°C with option HT
Relay Rating	6 Amp at 230 VAC

Table 1: Electrical Specifications

6 Application Specifications

Please refer to Table 2 for Application Specifications.

PARAMETER	VALUE
Sensitivity	<ul style="list-style-type: none"> • Dense Media/Build Up - 1 • Lighter Media - 5
Density of media (min)	0.7 gm/cm ³
Grain Size	A maximum of 12mm
Response Time with 'NS' option	<ul style="list-style-type: none"> • Cover Delay : 1-2 seconds • Uncover Delay : 1-3 seconds

Table 2: Application Specifications

7 Mechanical Specifications

Please refer to Table 3 for Mechanical Specifications.

PARAMETER	VALUE
Housing	<ul style="list-style-type: none"> ● SCUTE: Pressure die-cast aluminium weatherproof (Rating IP-68) ● FP2C: Cast aluminium, weatherproof & flameproof, powder coated, suitable for Gas Groups IIA, IIB & IIC as per IS-2148
Electrical Connector	PG-13.5, 1/2" BSP DC Glands, 1/2" NPT DC Glands
Mounting	<ul style="list-style-type: none"> ● Screwed - 1"/1 1/2" BSP/NTP(M) ● Flanged - As per your specifications ● Material - MS (Plated), SS
Sensing Fork	SS 316
Extension Pipe	GI (Galvanized Iron) / SS-304 / SS -316

Table 3: Mechanical Specifications

8 Installation & Handling Guidelines

The vibrosonde should be installed in horizontal or vertical position. The following image displays different allowable installation positions. Observe that when installed directly under the material inlet source, a canopy called baffle of appropriate strength and size should be welded right above the vibrating rod as shown.

While installing the instrument, please take care of the following points:

- The instrument shouldn't block the material filling inlet.
- Secure the cover of housing tightly. Tighten the cable glands.
- For side-mounting, provide a baffle to prevent the application material from falling on the vibrating rod. Please refer to Figure 3.

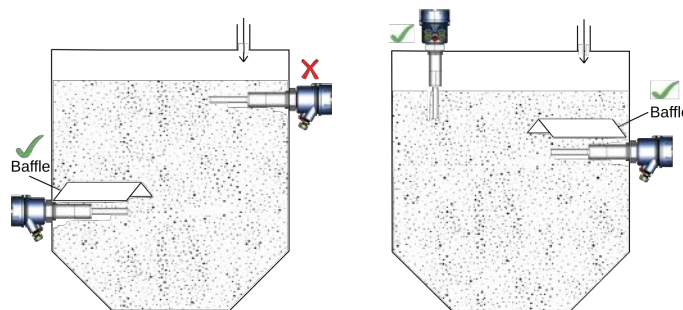

Figure 3: Correct Side Mounting

- When handling vibrating rod, do not lift them using their rod. Please see Figure 4.
- Make all electrical connections as instructed in the manual. Don't power on the device before verifying the connections.
- To prevent the ingress of moisture and water seepage in side mounting position, the cable entries should always point downwards.
- Weatherproofness of enclosure is guaranteed only if the cover is in place glands adequately tightened. Damage due to accidental entry of water can be avoided if the instrument is installed in a rain shade.

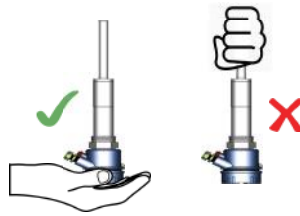

Figure 4: Instrument Handling

- If the ambient temperature is high, the instrument should not be installed to receive direct sunlight. In case such a position of shade is not available, a heat shield should be fitted above the instrument especially if the operating temperature lies between 60°C and 80°C.
- While screwing the instrument, the hexagonal mounting bush should be turned and not the housing.

9 Electrical Connections

Please refer to Figure 5 for electrical connections.

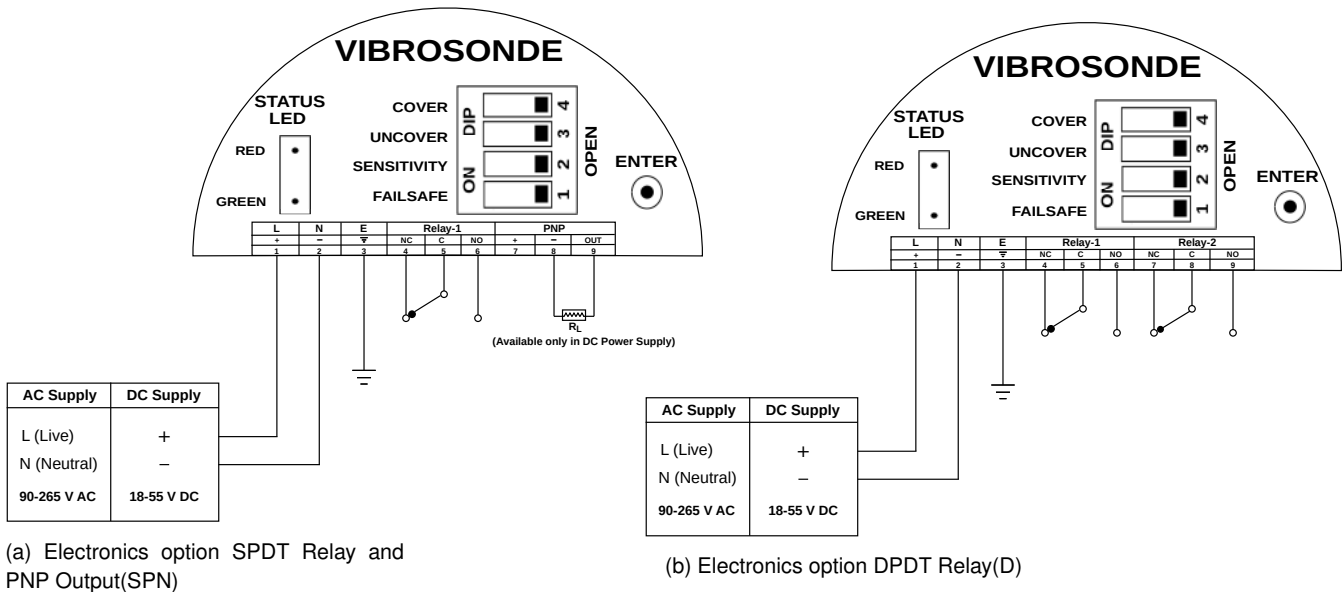

Figure 5: Electrical Connections

10 Sensitivity Settings

The sensitivity settings can be set as per the requirement using a DIP switch. The value of sensitivity is directly proportional to the number of blinks. 1 blink is the equivalent to the sensitivity value of 1. Thus, an increase in the number of blinks will make the instrument more sensitive.

Note:
You can set the value of SENSITIVITY between 1-5.

Follow the below procedure for setting sensitivity

1. Ensure that all DIP switches are in OPEN position as shown in Figure 6. Make sure that STATUS LED is not blinking for Error.



Figure 6: DIP Switch

2. To make the instrument sensitive, set the SENSITIVITY switch to CLOSE position as shown in figure 7. A small screw driver can be used for closing and opening of DIP Switch. (CLOSE is the opposite of OPEN for a DIP switch). The STATUS RED LED will glow.

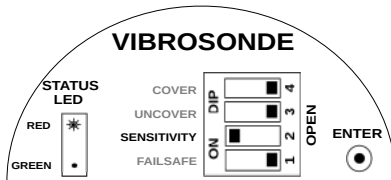

Figure 7: Sensitivity Switch Position

3. Press ENTER and keep it pressed as shown in Figure 8. The STATUS RED LED starts blinking. Count the number of blinks. After setting the value release the ENTER key.
 - 5 blinks indicate highest sensitivity which is required for low density materials.
 - 1 blink refers to lowest value of sensitivity which is required for normal solids.

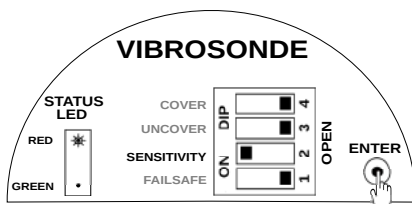

Figure 8: Setting Sensitivity Value

4. The value of sensitivity is now entered, but not saved. To save and test the sensitivity, set the SENSITIVITY switch back to OPEN position as shown in Figure 9. The STATUS LED will come back to its original position.

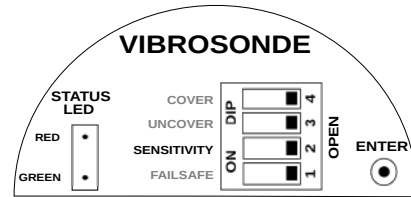

Figure 9: Saving Sensitivity Value

11 Cover Delay

When the application material covers the vibrating rod, the changeover of the output can be delayed by a pre-determined time. This time is called COVER Delay. For a different value of Cover Delay, the number of blinks can be adjusted as per requirement.

Note:
You can set the value of COVER DELAY between 1-25 secs.

Follow the below procedure for setting Cover Delay

1. Ensure that all DIP switches are in OPEN position as shown in Figure 6. Make sure that STATUS LED is not blinking for Error.
2. To set the Cover Delay, set the COVER switch to CLOSE position as shown in Figure 10. (CLOSE is the opposite of OPEN for a DIP switch.) The STATUS RED LED will glow.

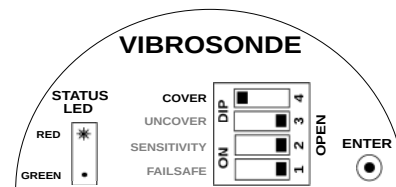

Figure 10: Cover Delay Switch Position

3. Press ENTER and keep it pressed as shown in Figure 11. The STATUS RED LED will start blinking. Count the number of blinks. After setting the value release the ENTER key.
4. Delay is entered, but not saved. To save and test the Cover Delay, set the COVER switch back to OPEN position as shown in Figure 12. The STATUS LED will come back to its original position.
5. To test, dip vibrosonde into the application material until the switching point is reached.

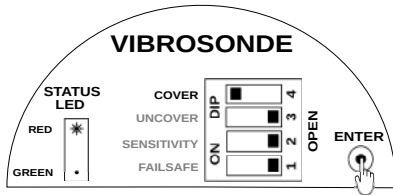

Figure 11: Setting Cover Delay

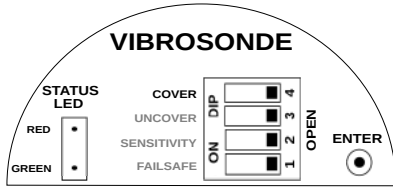

Figure 12: Saving Cover Delay

The STATUS LED will start blinking RED if the switch point is reached. It will blink for the number of seconds for which the cover delay is set. 1 blink is equal to 1 second during switching. A maximum of 25 seconds can be set.

12 Uncover Delay

When the application material uncovers vibrating rod, the changeover of the output can be delayed by a pre-determined time. This time is called UNCOVER Delay. For a different value of Uncover Delay, the number of blinks can be adjusted as per requirement.

Note:
You can set the value of UNCOVER DELAY between 1-25 secs.

Follow the below procedure for setting Uncover Delay

1. Ensure that all DIP switches are in OPEN position as shown in Figure 6. Make sure that STATUS LED is not blinking for Error.
2. To set the Uncover Delay, set the UNCOVER switch to CLOSE position as shown in Figure 13. (CLOSE is the opposite of OPEN for a DIP switch.) The STATUS RED LED will glow.

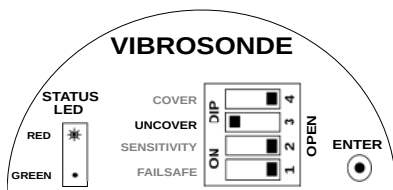

Figure 13: Uncover Delay Switch Position

3. Press ENTER and keep it pressed as shown in Figure 14. The STATUS RED LED will start blinking. Count the number of blinks. After setting the value release the ENTER key.

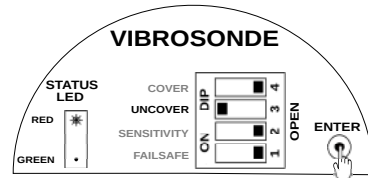

Figure 14: Setting Uncover Delay

4. Uncover Delay is entered, but not saved. To save and test the Uncover Delay, set the UNCOVER switch back to OPEN position as shown in figure 15. The STATUS LED will come back to its original position.

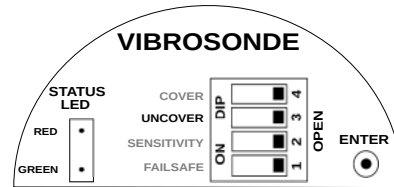

Figure 15: Saving Uncover Delay

5. To test, dip Vibrosonde into the application material until the switching point is achieved.
6. The STATUS LED will start blinking GREEN if the switch point is achieved. It will blink for the number of seconds for which the Uncover Delay is set.

13 Failsafe Settings

In a condition of device failure, known errors and input power failure the outputs of the device resemble the ALARM condition. This is meant to prevent overflow or dry run conditions in case of failures.

Prevent Overflow - High Level Switch Failsafe High (default) is set by moving the Failsafe switch to OPEN position.

1. When not in contact with the material, LED turns GREEN.
2. When in contact with the material, LED turns RED.

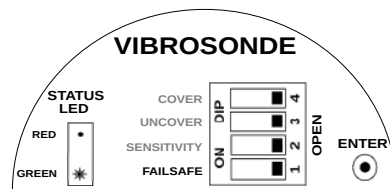

Figure 16: Failsafe High

Prevent Dry run - Low Level Switch Failsafe Low is set by moving the Failsafe switch to CLOSE position

1. When in contact with the material, LED turns GREEN.
2. When not in contact with the material, LED turns RED.

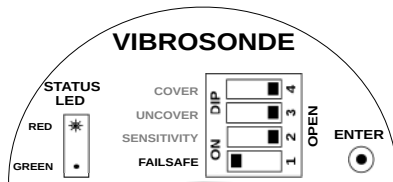

Figure 17: Failsafe Low

14 Troubleshooting & Indications

14.1 Output Indications

Green LED Glows When:

- Vibrating Rod is Uncovered and Failsafe is High
- Vibrating Rod is Covered and Failsafe is Low

Red LED Glows When:

- Vibrating Rod is Covered and Failsafe is High
- Vibrating Rod is Uncovered and Failsafe is Low

14.2 Troubleshooting

- Heavy build-up of application material can dampen the rod oscillations. In this case, the vibrating rod requires to be cleaned. To avoid build up change sensitivity value to 1.
- If the vibrating rod is not sensing application media, consider changing the sensitivity.
- If instrument is not powering on (No LED is glowing). Check input supply voltage. It should be in the range mentioned in Electrical Specifications
- **Connectivity between Vibrating Rod and Electronics is broken**
 - In failsafe 'High' mode, instrument will switch to ALARM
 - In failsafe 'Low' mode, instrument will switch to NORMAL

15 Maintenance

The electronics of vibrosonde instrument needs no maintenance. When cleaning and checking the vessel, free the vibrating rod from deposits. If the material has tendency to form a hard sticky deposit, the instrument must be checked more often. Make sure that the cable ducts and the lid are tightly sealed so that no moisture seeps into the instrument.

16 Customer Support

Thank you for going through the instructions given in this manual. To further ease the process of installation and use,

we have developed special demo videos which are hosted on YouTube.

Sapcon's YouTube channel, SAPCON INSTRUMENTS, lists all these videos: <https://goo.gl/dnxfcz>

Should you require further information regarding installation, use or working of the instrument, please don't hesitate to contact us. Kindly provide the following information at the time of contacting:

- Instrument Model and Serial Number
- Purchase Order Number and Date of Purchase
- Description of the query
- Your contact details

In an attempt to serve you better, we are open seven days a week (9:30am to 7:30pm). We are available at:

- www.sapconinstruments.com
- sales@sapcon.in
- +91-731-4757575

17 Production Selection Order Code

Product

VS : Vibrosonde - Vibrating Rod Level Limit Switch (use in Powders, Sand, Sugar, Pulverized Coal, Food Grains, Cement, Granular Material)

Type

I : Integral (sensor in same unit)

Housing

SCUTE : Pressure Die Cast Aluminium weather proof (Rating IP-68) SCUTE

FP2C : Cast Aluminium weather & flame proof powder coated suitable for gas group IIC

Indication (Optional)

WL : External LED Indication (Only with "SCUTE")

Probe Housing Cable Entry

👍 PCPG13 : PG 13.5, Polyamide

👍 PCB5D : 1/2" BSP, DC Gland, Brass

PCN5D : 1/2" NPT, DC Gland, Brass

Output

SPN : SPDT Relay output 1NO, 1NC (Relay rated at 6 A, 230 V AC for non-inductive load) and PNP output (only for supply voltage 18V to 35V DC)

👍 D : 2NO, 2NC DPDT Relay Output (rated at 6 A, 230 V AC for non-inductive load)

Power Supply

U : Universal (18 to 55V DC) and (90 to 265V at 50Hz AC)

Switching

NS : Normal Time Delay (Adjustable from 2 to 20 seconds for probe covered or uncovered)

Mounting

👍 MB15S4 : Screwed Thread, BSP 1-1/2", SS 304

MB15S6 : Screwed Thread, BSP 1-1/2", SS 316

MN15S4 : Screwed Thread, NPT 1-1/2", SS 304

MN15S6 : Screwed Thread, NPT 1-1/2", SS 316

FA20S4 : 2" ANSI Flange, SS 304

FA20S6 : 2" ANSI Flange, SS 316

FA25S4 : 2-1/2" ANSI Flange, SS 304

FA25S6 : 2-1/2" ANSI Flange, SS 316

FA30S4 : 3" ANSI Flange, SS 304

F20S4 : 2" ASA Flange, 10mm thickness, SS 304

F20S6 : 2" ASA Flange, 10mm thickness, SS 316

F25S4 : 2-1/2" ASA Flange, 10mm thickness, SS 304

F25S6 : 2-1/2" ASA Flange, 10mm thickness, SS 316

F20B15S4 : 2" ASA Slip-ON Flange with 1-1/2" BSP Thread, 10mm thickness, SS 304

F20B15S6 : 2" ASA Slip-ON Flange with 1-1/2" BSP Thread, 10mm thickness, SS 316

F25B15S4 : 2-1/2" ASA Slip-ON Flange with 1-1/2" BSP Thread, SS 304

F25B15S6 : 2-1/2" ASA Slip-ON Flange with 1-1/2" BSP Thread, SS 316

Vibrating Rod

VS162 : Active Rod Length 162mm, Material SS 316

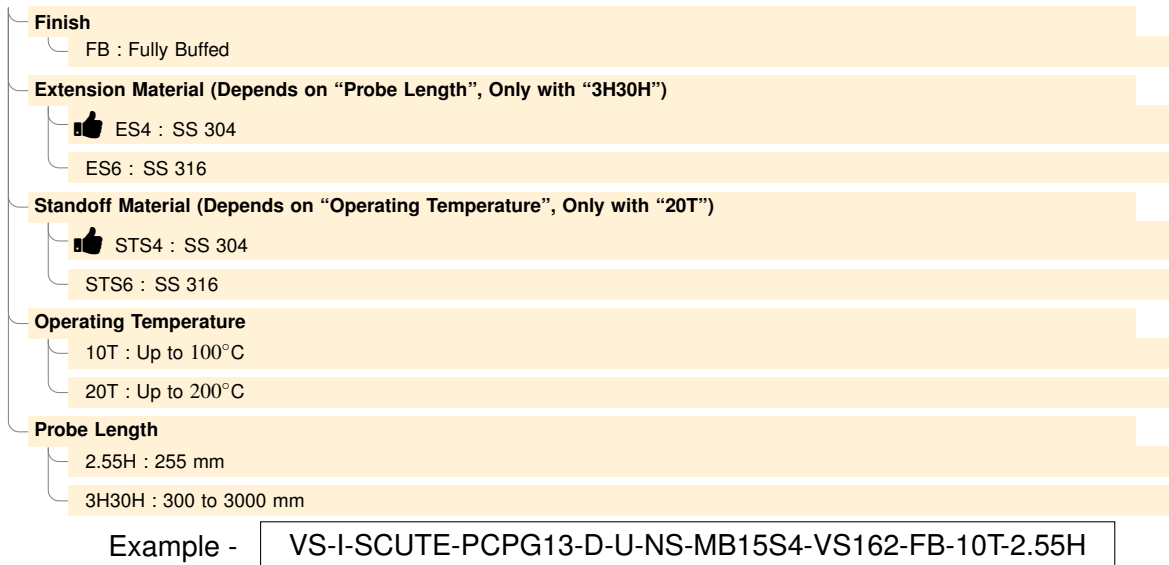

👍 Shows First Priority Entity